

Features

- Low $R_{DS(ON)}$
- Fast switching
- Low gate charge
- Low Reverse transfer capacitances
- RoHS compliant with Halogen-free

HF

Mechanical Data

- Case: TO-220AB, TO-263, ITO-220AB
- Molding Compound: UL Flammability Classification Rating 94V-0
- Terminals: Matted-Tin plated; Solderable Per MIL-STD-202, Method 208

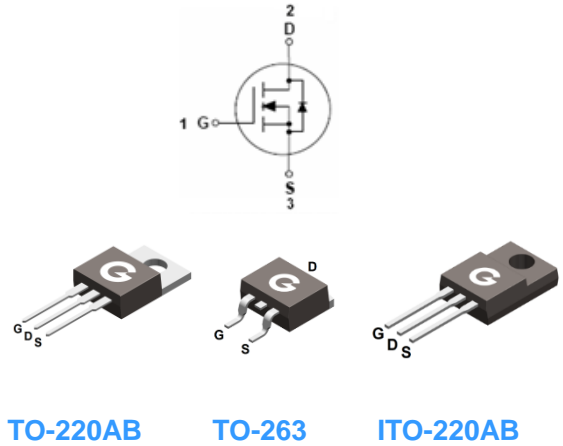

TO-220AB

TO-263

ITO-220AB

Ordering Information

Part Number	Package	Shipping Quantity	Marking Code
BL10N65	TO-220AB	50 pcs / Tube	10N65
BL10N65B	TO-263	50 pcs / Tube or 800 pcs / Tape & Reel	10N65B
BL10N65F	ITO-220AB	50 pcs / Tube	10N65F

Maximum Ratings (@ $T_C = 25^\circ\text{C}$ unless otherwise specified)

Parameter	Symbol	Value	Unit
Drain-to-Source Voltage	V_{DSS}	650	V
Gate-to-Source Voltage	V_{GSS}	± 30	V
Continuous Drain Current ($T_C = 25^\circ\text{C}$)	I_D	10	A
Continuous Drain Current ($T_C = 100^\circ\text{C}$)		6.3	A
Pulsed Drain Current ($t_p = 10\mu\text{s}$, $T_C = 25^\circ\text{C}$)	I_{DM}	40	A
Single Pulse Avalanche Energy ^{*2}	E_{AS}	500	mJ
Power Dissipation (TO-220AB, $T_C = 25^\circ\text{C}$)	P_D	147	W
Power Dissipation (TO-263, $T_C = 25^\circ\text{C}$)		147	W
Power Dissipation (ITO-220AB, $T_C = 25^\circ\text{C}$)		40	W
Operating Junction Temperature Range	T_J	$-55 \sim +150$	$^\circ\text{C}$
Storage Temperature Range	T_{STG}	$-55 \sim +150$	$^\circ\text{C}$

Thermal Characteristics

Parameter	Symbol	TO-220AB/TO-263	ITO-220AB	Unit
Thermal Resistance Junction-to-Case	$R_{\theta JC}$	0.85	3.1	$^\circ\text{C/W}$
Thermal Resistance Junction-to-Air	$R_{\theta JA}$	50	62.5	$^\circ\text{C/W}$

Electrical Characteristics (@ $T_A = 25^\circ\text{C}$ unless otherwise specified)

Symbol	Parameter	Test Condition	Min.	Typ.	Max.	Unit
Static Characteristics						
V_{DSS}	Drain-Source Breakdown Voltage	$V_{GS} = 0V, I_D = 250\mu A$	650	-	-	V
I_{DSS}	Zero Gate Voltage Drain Current	$V_{DS} = 650V, V_{GS} = 0V$	-	-	1	μA
I_{GSS}	Gate-Body Leakage Current	$V_{GS} = \pm 30V, V_{DS} = 0V$	-	-	± 100	nA
On Characteristics						
$R_{DS(ON)}$	Drain-Source On-resistance *1	$V_{GS} = 10V, I_D = 5A$	-	-	1	Ω
$V_{GS(th)}$	Gate Threshold Voltage	$V_{DS} = V_{GS}, I_D = 250\mu A$	2	-	4	V
Dynamic Characteristics						
C_{ISS}	Input Capacitance	$V_{GS} = 0V$	-	1642	-	pF
C_{OSS}	Output Capacitance	$V_{DS} = 25V$	-	128	-	
C_{RSS}	Reverse Transfer Capacitance	$f = 1MHz$	-	7	-	
Switching Characteristics						
$t_{d(ON)}$	Turn-on Delay Time *3	$V_{DD} = 325V$ $I_D = 10A$ $R_G = 10\Omega$	-	27	-	ns
t_r	Turn-on Rise Time *3		-	22	-	
$t_{d(OFF)}$	Turn-Off Delay Time *3		-	53	-	
t_f	Turn-Off Fall Time *3		-	24	-	
Q_G	Total Gate-Charge	$V_{DD} = 520V$	-	32	-	nC
Q_{GS}	Gate to Source Charge	$V_{GS} = 10V$	-	8	-	
Q_{GD}	Gate to Drain (Miller) Charge	$I_D = 10A$	-	12	-	
Source-Drain Diode Characteristics						
V_{SD}	Diode Forward Voltage *1	$I_{SD} = 10A, V_{GS} = 0V$	-	-	1.5	V
t_{rr}	Reverse Recovery Time	$I_{SD} = 10A, V_{GS} = 0V$	-	530	-	ns
Q_{rr}	Reverse Recovery Charge	$dI/dt = 100A/\mu s$	-	3.2	-	μC

Notes:

- The data tested by pulsed, pulse width $\leq 300\mu s$, duty cycle $\leq 2\%$
- The E_{AS} data shows Max. rating. The test condition is $V_{DD} = 100V, V_{GS} = 15V, L = 50mH$
- Guaranteed by design, not subject to production

Ratings and Characteristics Curves (@ $T_A = 25^\circ\text{C}$ unless otherwise specified)

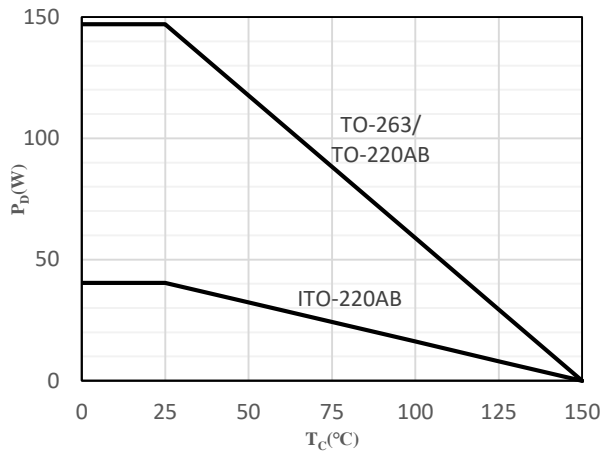

Fig 1 Power Dissipation

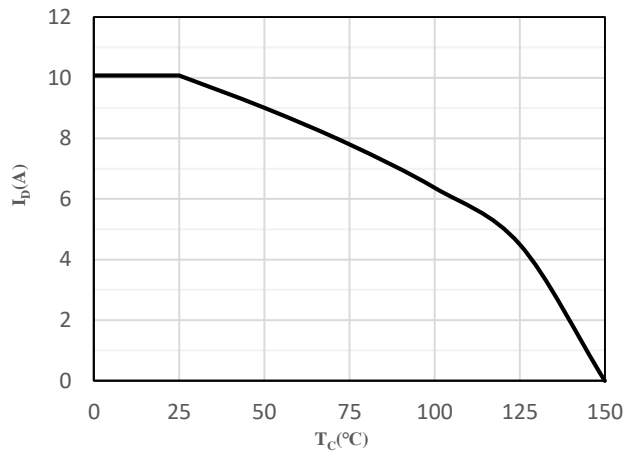

Fig 2 Drain Current

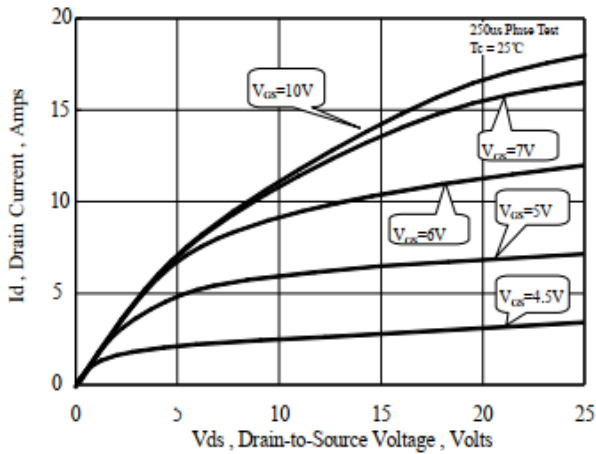

Fig 3 Typical Output Characteristics

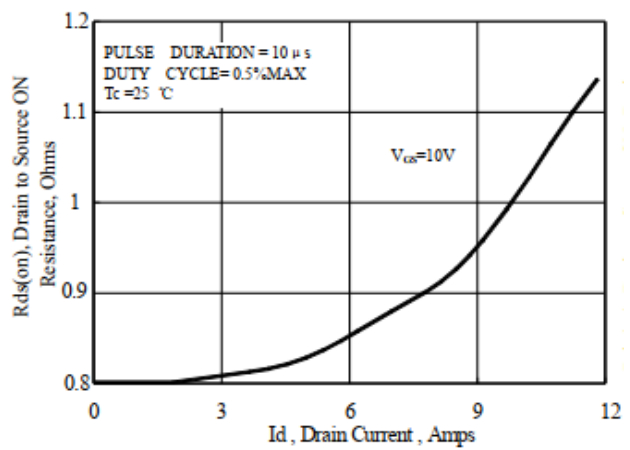

Fig 4 On-Resistance vs. Drain Current and Gate Voltage

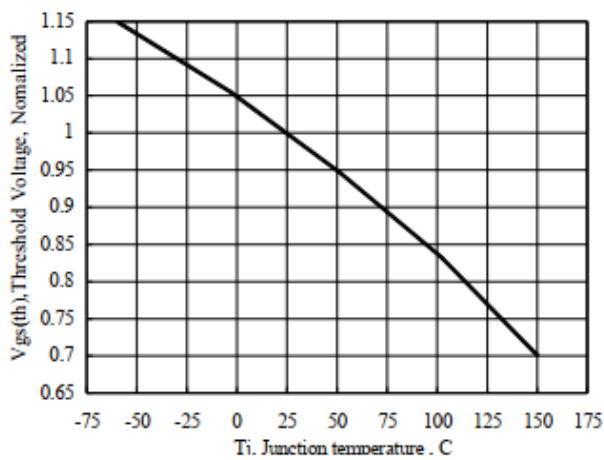

Fig 5 Normalized $V_{GS(th)}$ vs. Junction Temperature

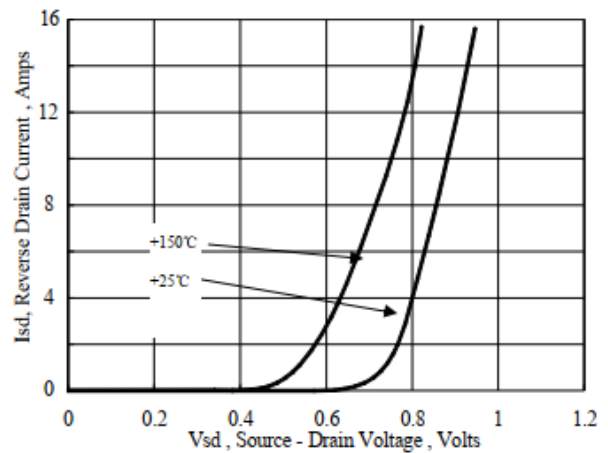

Fig 6 Body-Diode Characteristics

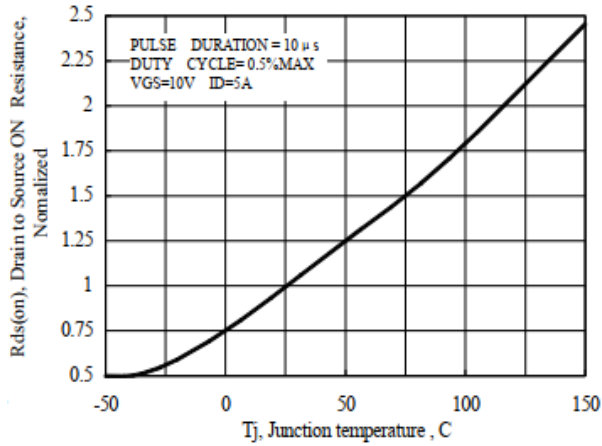

Fig 7 Normalized On-Resistance vs. Junction Temperature

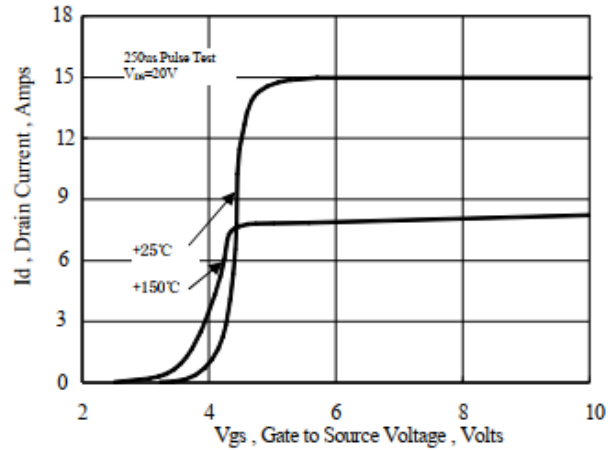

Fig 8 Transfer Characteristics

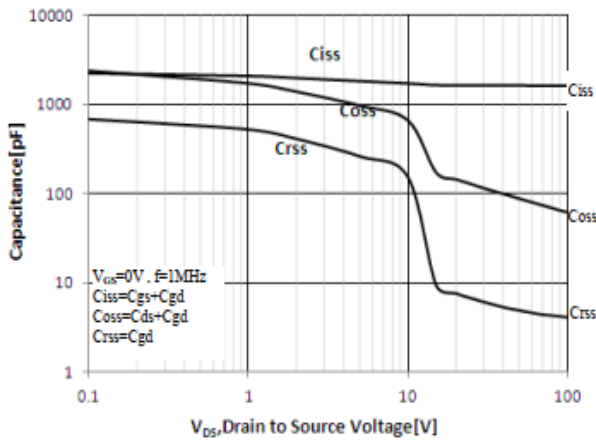

Fig 9 Capacitance Characteristics

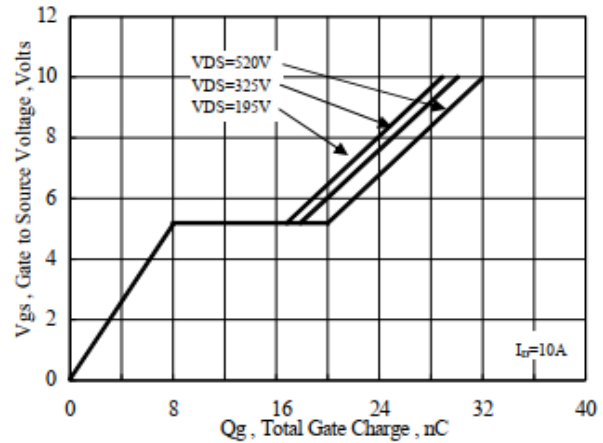

Fig 10 Gate-Charge Characteristics

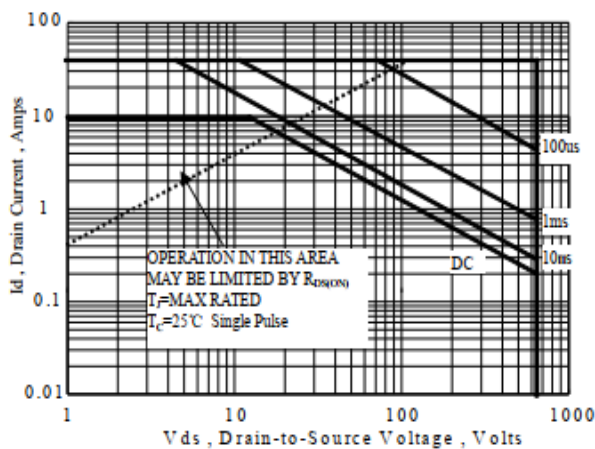

Fig 11 Safe Operation Area (TO-220AB / TO-263)

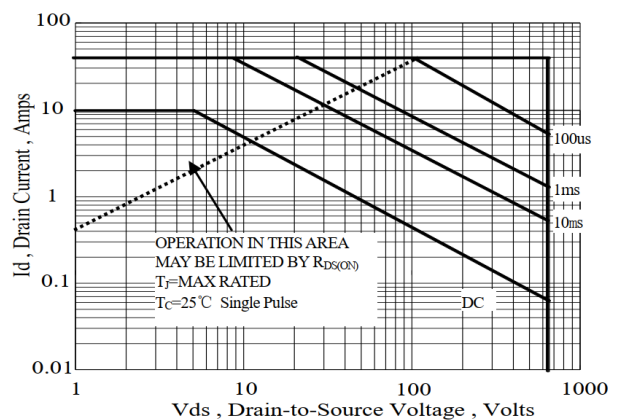
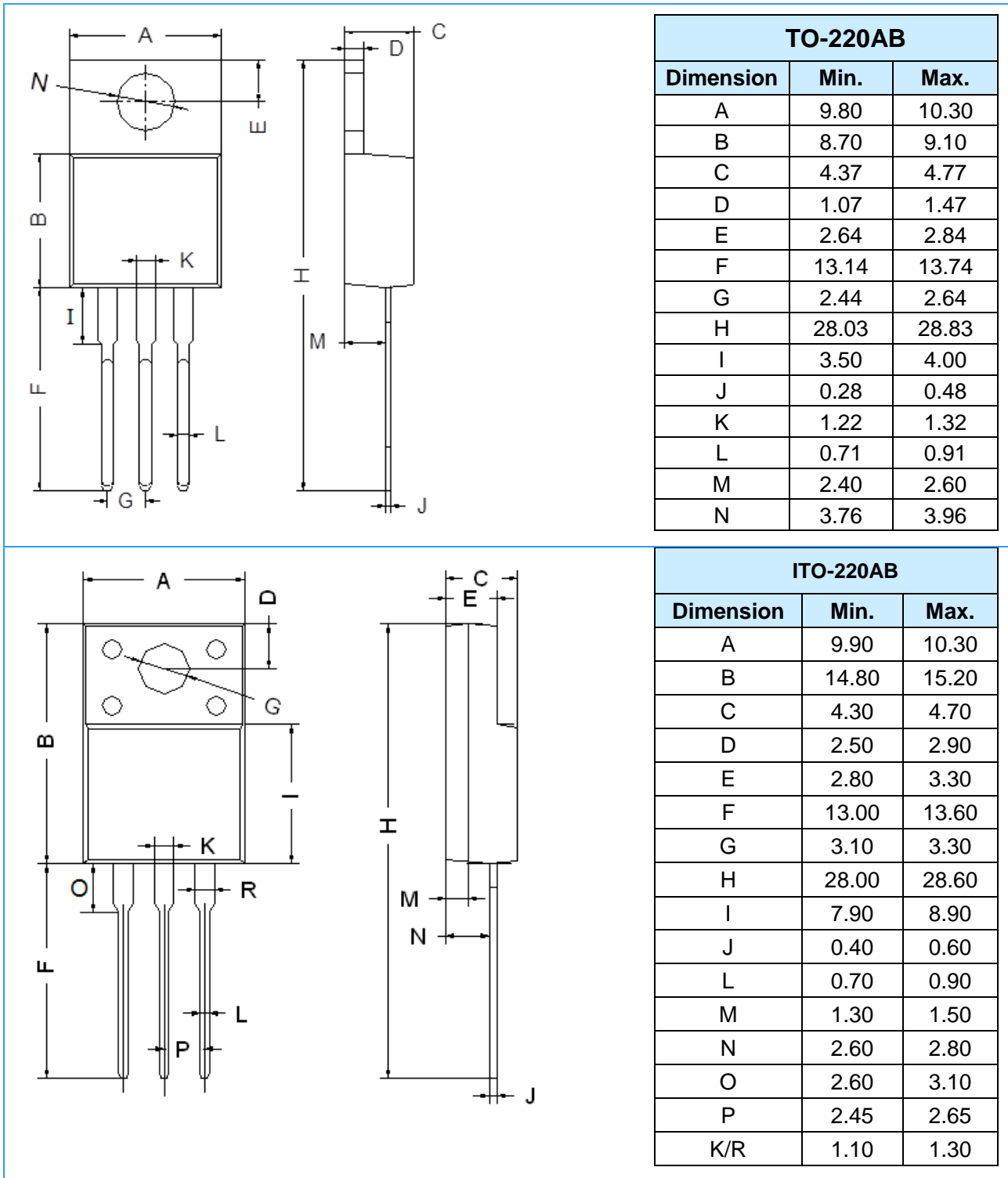
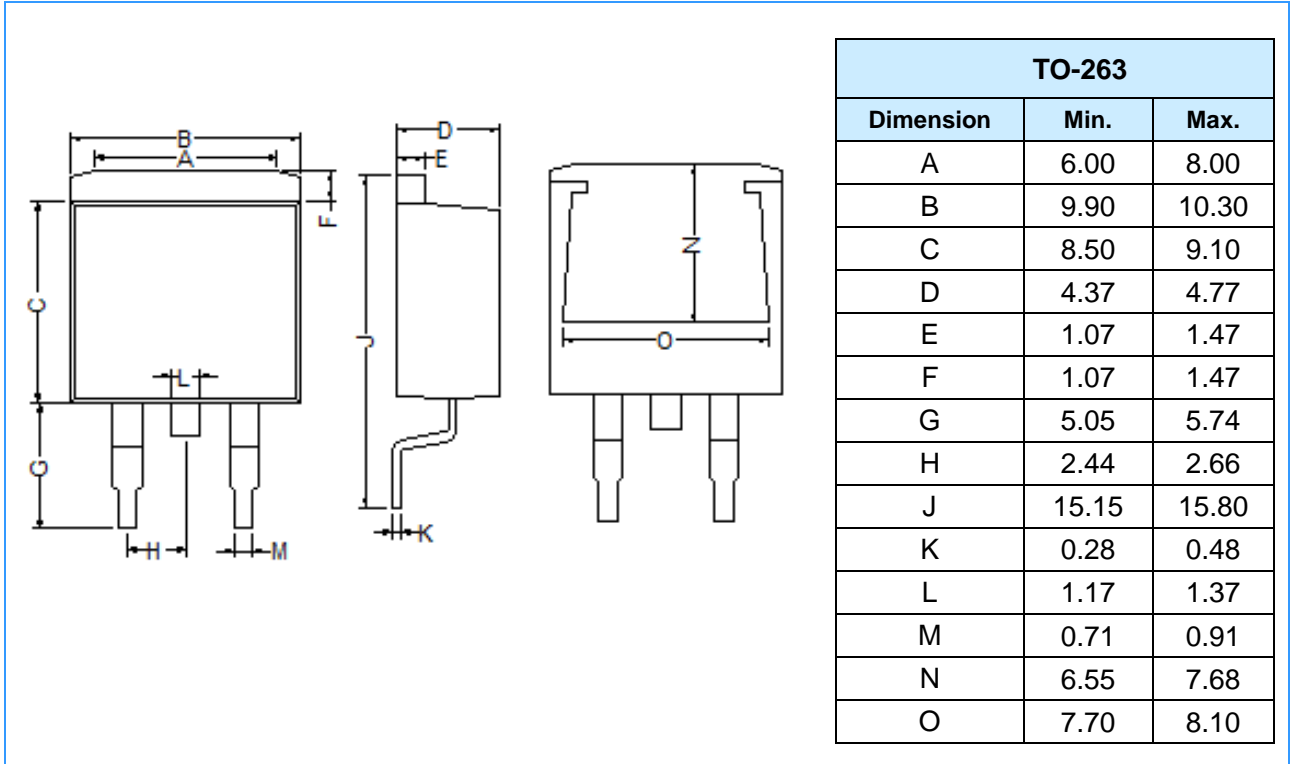

Fig 12 Safe Operation Area (ITO-220AB)

Package Outline Dimensions (Unit: mm)





Mounting Pad Layout (Unit: mm)

